

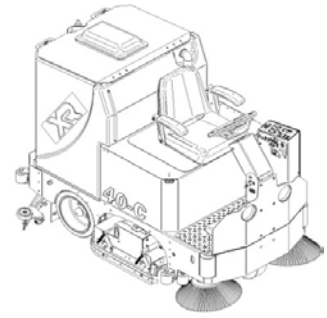

XR Scrubber  
Specifications



**Disc**

**Cylindrical**

**BODY CONSTRUCTION / DIMENSIONS:**

Tank Material:	Poly (3/8" thick) (.9525 cm)	Poly (3/8" thick) (.9525 cm)
Frame Construction:	7-gauge (3/16" Steel) (.47625 cm)	7-gauge (3/16" Steel) (.47625 cm)
Rear Wheels (diameter x width):	14" x 5" (35.5 cm x 13 cm)	14" x 5" (35.5 cm x 13 cm)
Drive Wheel (diameter x width):	12" x 4" (30.5 cm x 10 cm)	12" x 4" (30.5 cm x 10 cm)
Size (L x W x H):	69" x 36" x 56" (175 cm x 91 cm x 142 cm)	69" x 36" x 56" (175 cm x 91 cm x 142 cm)
Weight:	1,230 lbs. (558 kg)	1,230 lbs. (558 kg)
Weight (w / batteries):	1,950 lbs. (885 kg)	1,950 lbs. (885 kg)

**BRUSH SYSTEM:**

Brush Down Pressure	0-350 lbs. (0-159 kg)	0-350 lbs. (0-159 kg)
Brush Pressure Settings	(5) w / auto adjust	(5) w / auto adjust
Brush /Pad Size:	34D: (2) 17" (43 cm) 40D: (2) 20" (51 cm) 45: (2) 23" (58 cm)	34C: (2) 32" x 7" (81 cm x 18 cm) 40C: (2) 38" x 7" (96.5 cm x 18 cm) 46C: (2) 44" x 7" (112 cm x 18 cm)
Brush Speed	270-rpm	750-rpm
Motor Power:	(2) 1.5 hp (1,119 watts)	(2) 1.5 hp (1,119 watts)

**BATTERY SYSTEM:**

Battery AH Rating (standard):	(Qty 6) 325 AH	(Qty 6) 325 AH
Battery AH Rating (optional):	(Qty 6) 395 AH	(Qty 6) 395 AH
Battery AH Rating (industrial battery):	(Qty 1) 440 AH	(Qty 1) 440 AH
Battery Run Time:	Up to 6 hours	Up to 6 hours
Charger (110-v / 60 Hz / 36-volt):	36-v / 36 amp	36-v / 36 amp

**SOLUTION SYSTEM:**

Solution Tank Capacity:	65-gallons (246 liters)	65-gallons (246 liters)
Solution Flow Rate:	0-1.5 gpm (0-6 lpm)	0-1.5 gpm (0-6 lpm)
Solution Filter:	Inline Stainless	Inline Stainless

**RECOVERY SYSTEM:**

Recovery Tank Capacity:	78-gallons (295 liters)	78-gallons (295 liters)
Vacuum Power:	1.6 hp (1,193 watts)	1.6 hp (1,193 watts)
Vacuum (lift / airflow):	70" / 140 cfm (178 cm / 42 cmm)	70" / 140 cfm (178 cm / 42 cmm)
Demisting Chamber:	2.5 gallons (9 liters)	2.5 gallons (9 liters)

**DRIVE SYSTEM:**

Power:	3.0 hp, sealed (2,237 watts)	3.0 hp, sealed (2,237 watts)
Type:	All Gear	All Gear
Speed Control:	Variable 0-320 ft. (0-97.5 meters)	Variable 0-320 ft. (0-97.5 meters)

**GENERAL:**

Sound Levels:	71 dBA	71 dBA
Side Broom Path:	45" (114 cm)	45" (114 cm)
Cleaning Width:	34D: 34"/36,720 sq. ft./hr. (3,411 sq. m/hr.) 40D: 40"/43,200 sq. ft./hr. (4,013 sq. m/hr.) 45D: 45"/48,600 sq. ft./hr. (4,515 sq. m/hr.)	34C: 34"/36,720 sq. ft./hr. (3,411 sq. m/hr.) 40C: 40"/43,200 sq. ft./hr. (4,013 sq. m/hr.) 46C: 46"/49,680 sq. ft./hr. (4,615 sq. m/hr.)

**RPS CORPORATION**

P.O. Box 368  
Racine, WI 53401  
Phone: (800)634-4060  
Fax: (866)901-3335

© RPS Corporation 2015.  
All Rights Reserved.

Since our policy is one of constant improvement,  
all specifications are subject to change without notice.

**AUTHORIZED DISTRIBUTOR**